

KASNAK TİPLERİ



KASNAK YAPIMINDA KULLANILAN MALZEME GG25 DÖKÜM İŞLEMİNE GÖRE İMAL EDİLMİŞTİR. HER KASNAK DİNAMİK OLARAK BALANS EDİLMİŞTİR. GÜVENLİ OLARAK KULLANILABİLİR.

KASNAK ÖLÇÜLERİ

	a	b	c	d	e	f	h	34°	38°
SPZ	9.7	8.5	8	12	8	2.5	12	P<=80	P>=80
SPA	12.7	11	10	15	10	3.5	15	P<=118	P>=118
SPB	16.3	14	12.5	19	12.5	4	18	P<=190	P>=190
SPC	22	19	16	25	16	5	24	P<=315	P>=315

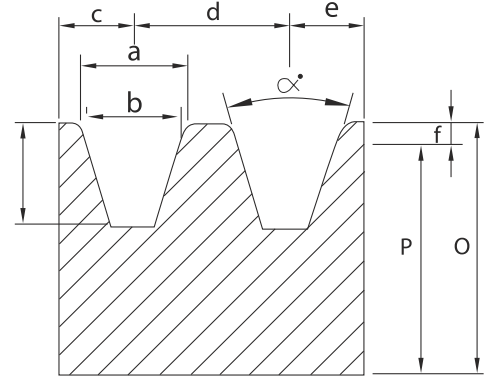

KAYIŞ ÖLÇÜLERİ

	m	s	n
SPZ	9.7	8	8.5
SPA	12.7	10	11
SPB	16.3	13	14
SPC	22	18	19

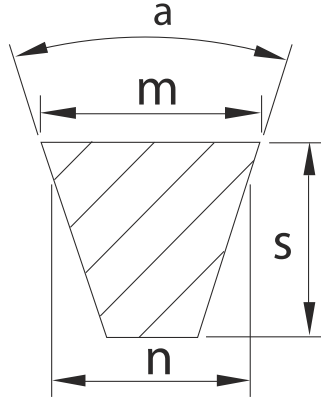

TİP 1

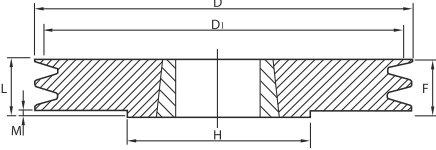

TİP 2

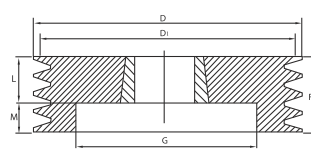

TİP 3

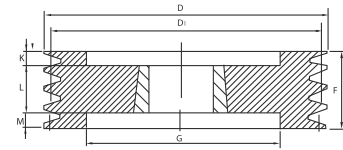

TİP 4

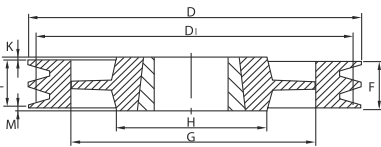

TİP 5

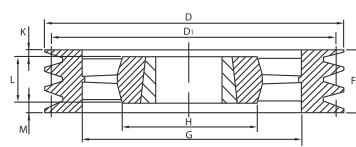

TİP 6

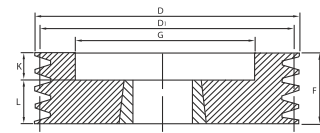

TİP 7

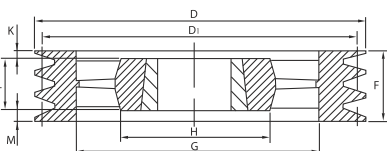

TİP 8

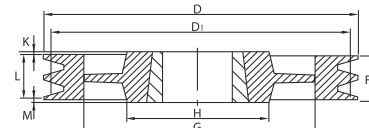

TİP 9

